

Наименование деталей







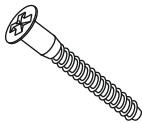

1. Боковина левая	900x305	1 шт.	6. Стенка левая ДВПО	426x295	1 шт.
2. Боковина правая	900x305	1 шт.	7. Стенка правая ДВПО	426x295	1 шт.
3. Полка стационарная	584x584	2 шт.	8. Стенка ДВПО	426x295	4 шт.
4. Полка стац. средняя	564x564	2 шт.	9. Дверь ун. МДФ	920x392	1 шт.
5. Ригель	866x230	1 шт.			

Необходимый инструмент

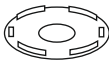

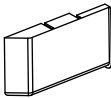
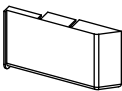
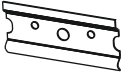
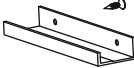
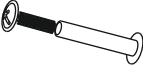
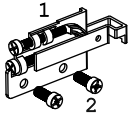
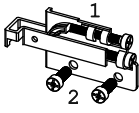
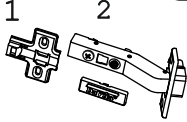
Установите на шуруповерте минимальные обороты!

Фурнитура в комплекте

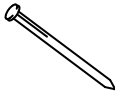
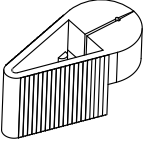
а		б		в		г		д		е		ж	
													
Демпфер 11x5 с/кл	2 шт.	Евровинт 50	20 шт.	Загл к ев. винту	20 шт.	Заглушка 35 бел.	3 шт.	Загл. самокл. Д14	17 шт.	Заглушка Scarpi-4 лев	1 шт.	Заглушка Scarpi-4 прав	1 шт.
з		и		к		л		м		н		о	
													
Крепеж полоса	2 шт.	Ручка P423	1 шт.	Стяжка 30 мм	3 компл.	Навес Scarpi-4 лев	1 шт.	Навес Scarpi-4 прав	1 шт.	Петля 45 гр Н-0 с доводчиком и заглушкой	3 шт.	Шайба КРАБ	16 шт.
п		р		с		т							
													
Шуруп 3x12 п/сфера	22 шт.	Шуруп 4x16	12 шт.	Гвоздь 1,6x25	20 шт.	Держатель для гвоздя	1 шт.						



Рис. 1



Рис. 2

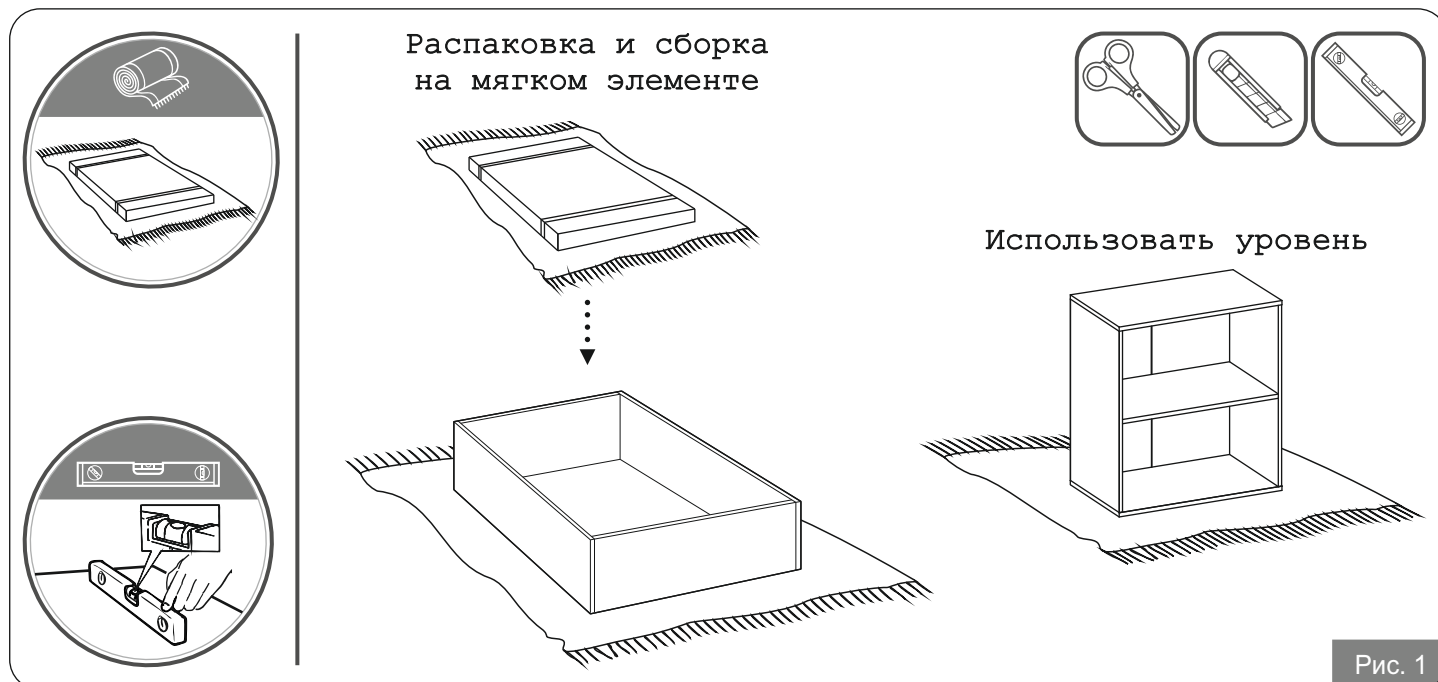

Рис. 3

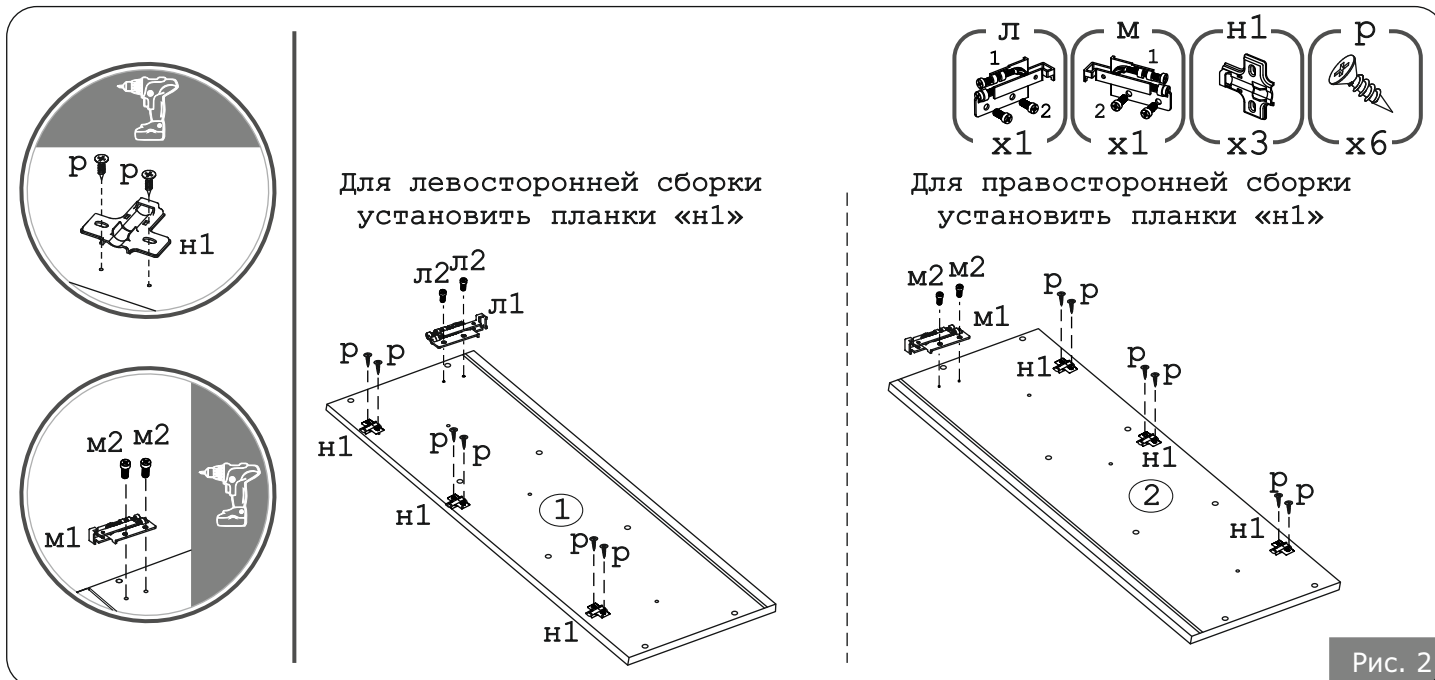

Рис. 4



Рис. 5

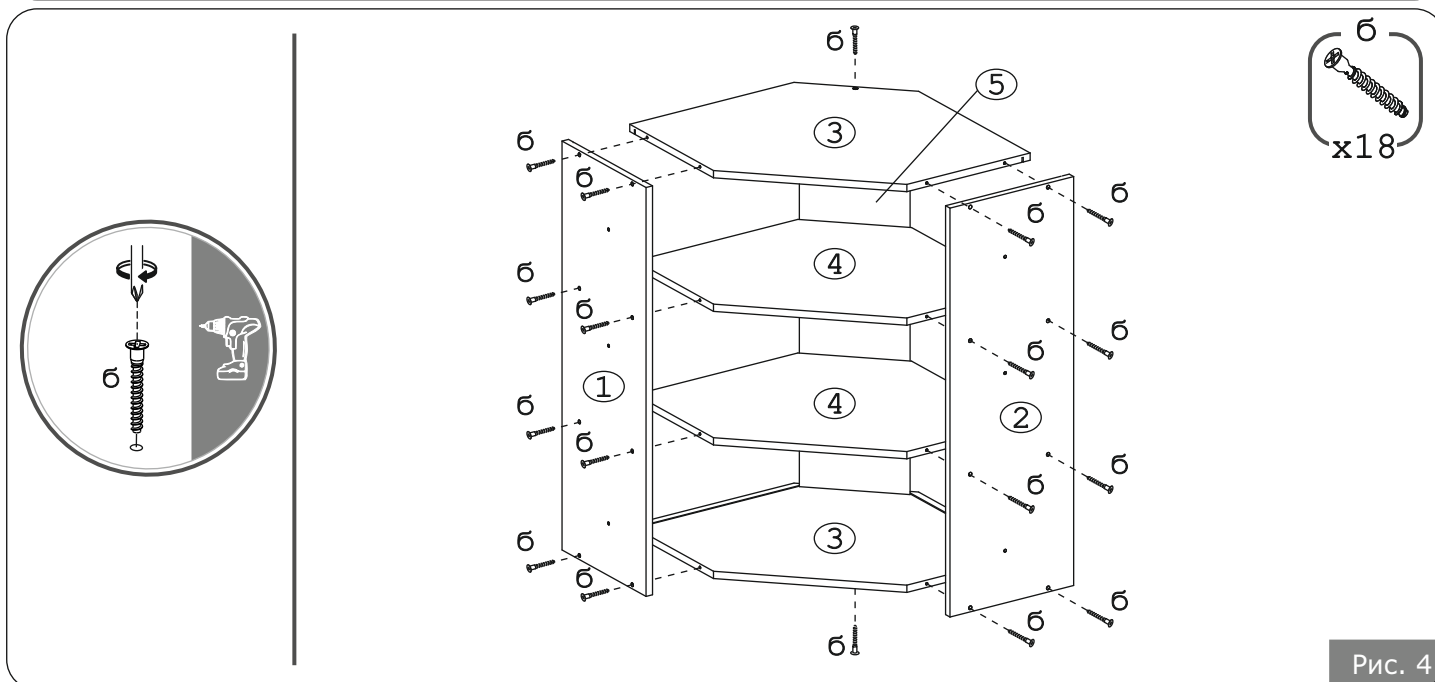

Рис. 6

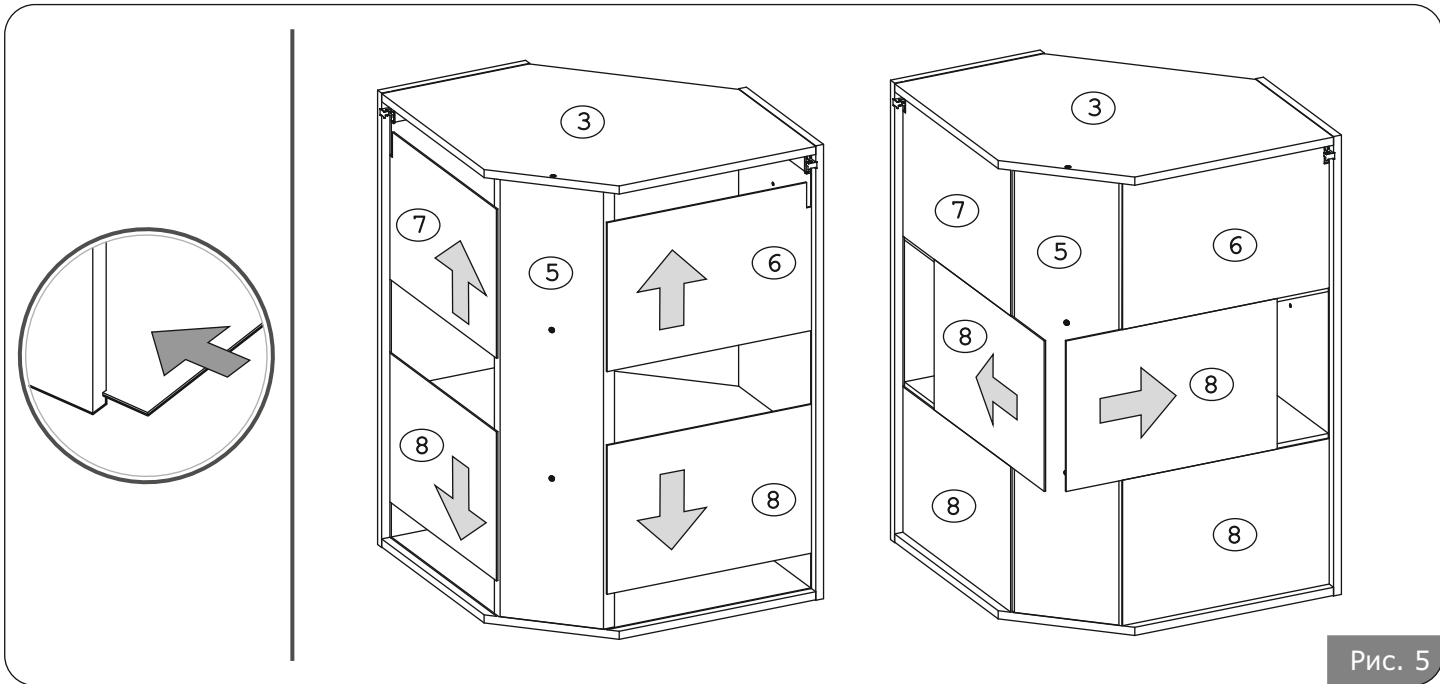

Рис. 7

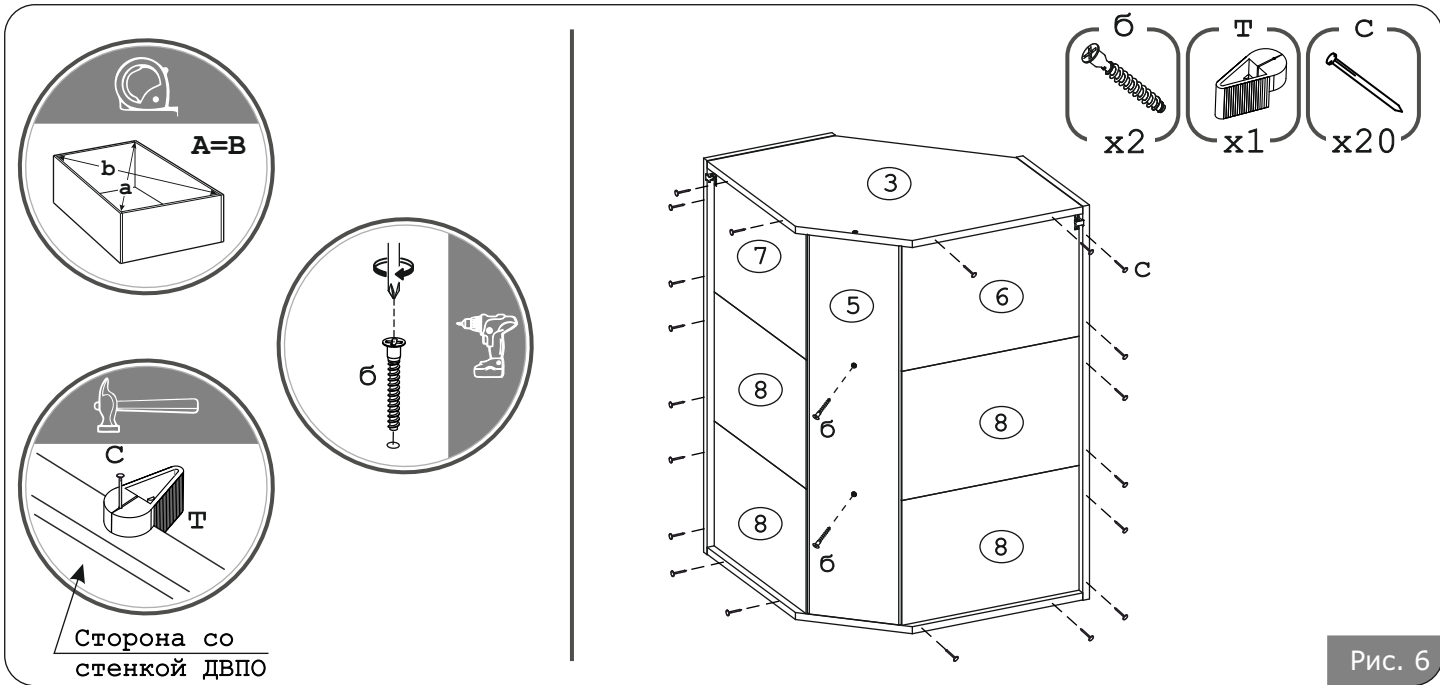

Рис. 8

Регулировка
петель

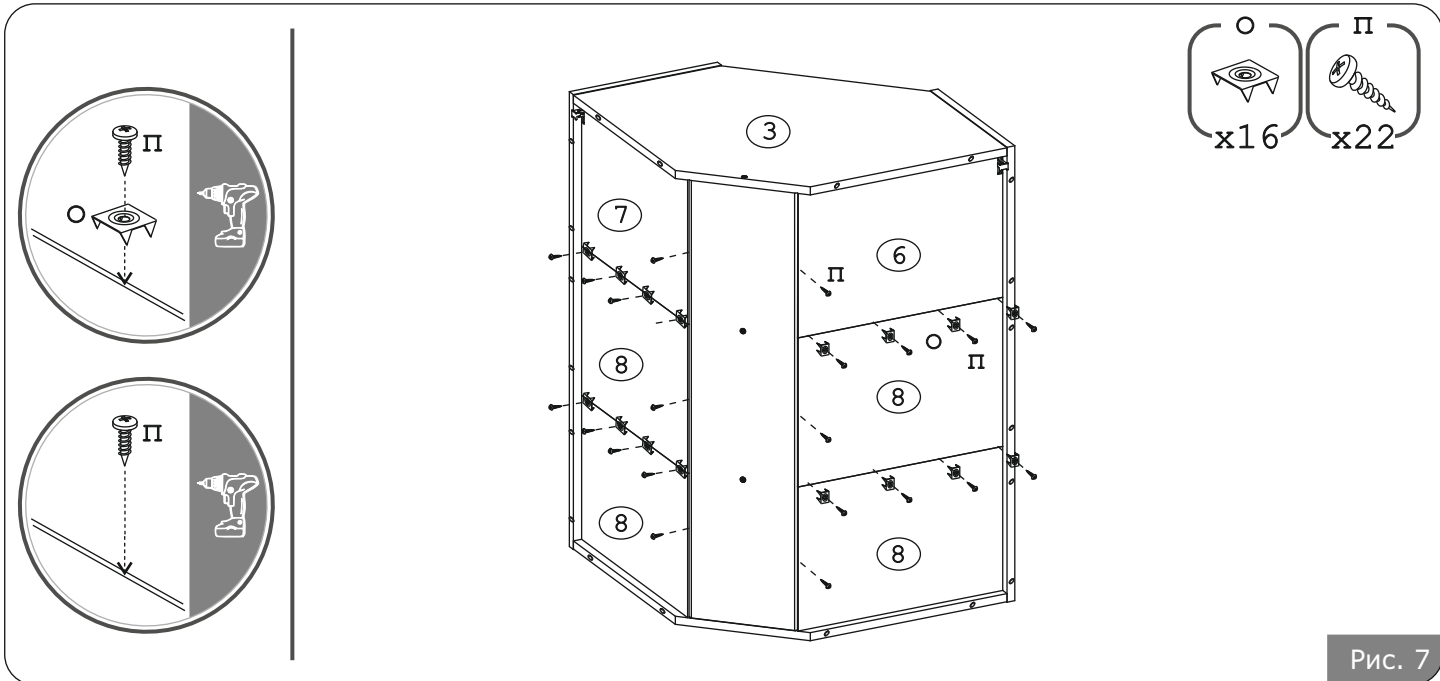

По желанию можно установить ручку или открывать дверь за счет свеса фасада.

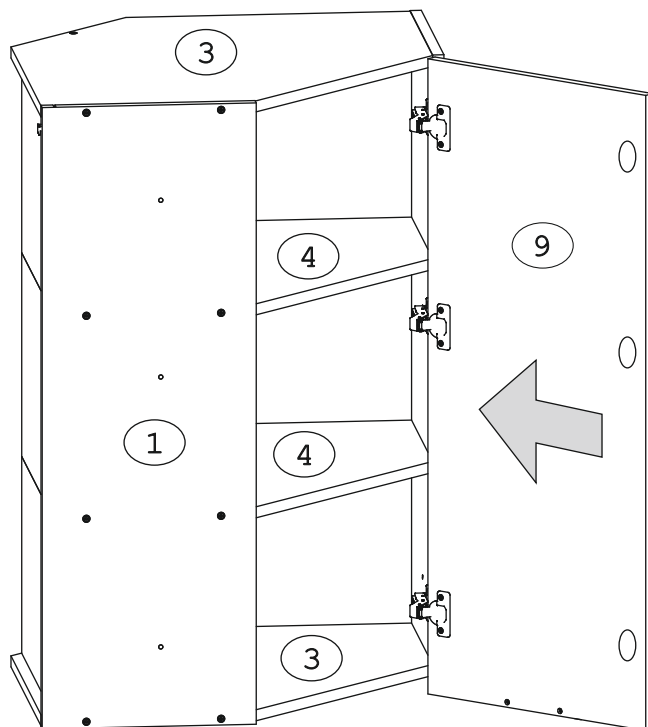
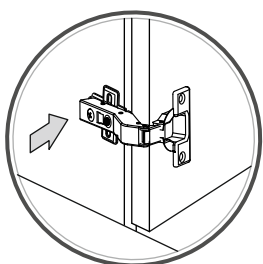
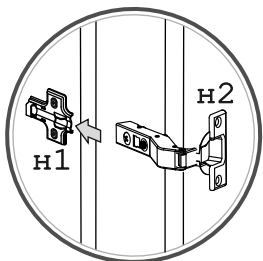
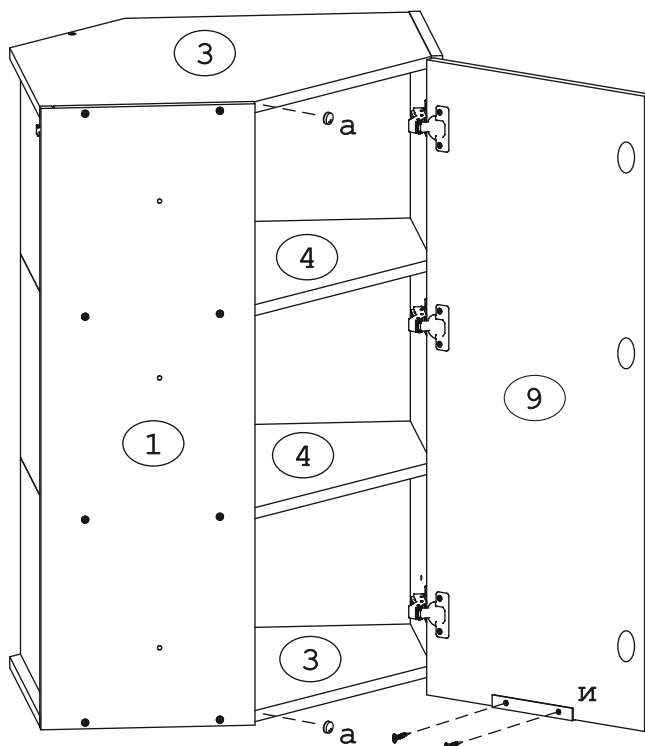
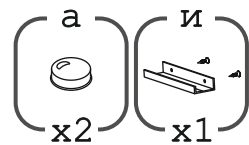
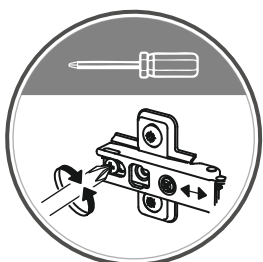
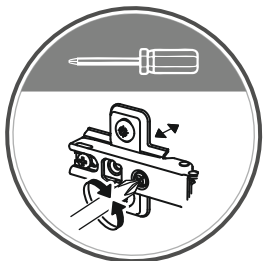
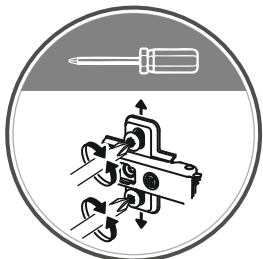
Рис. 9