

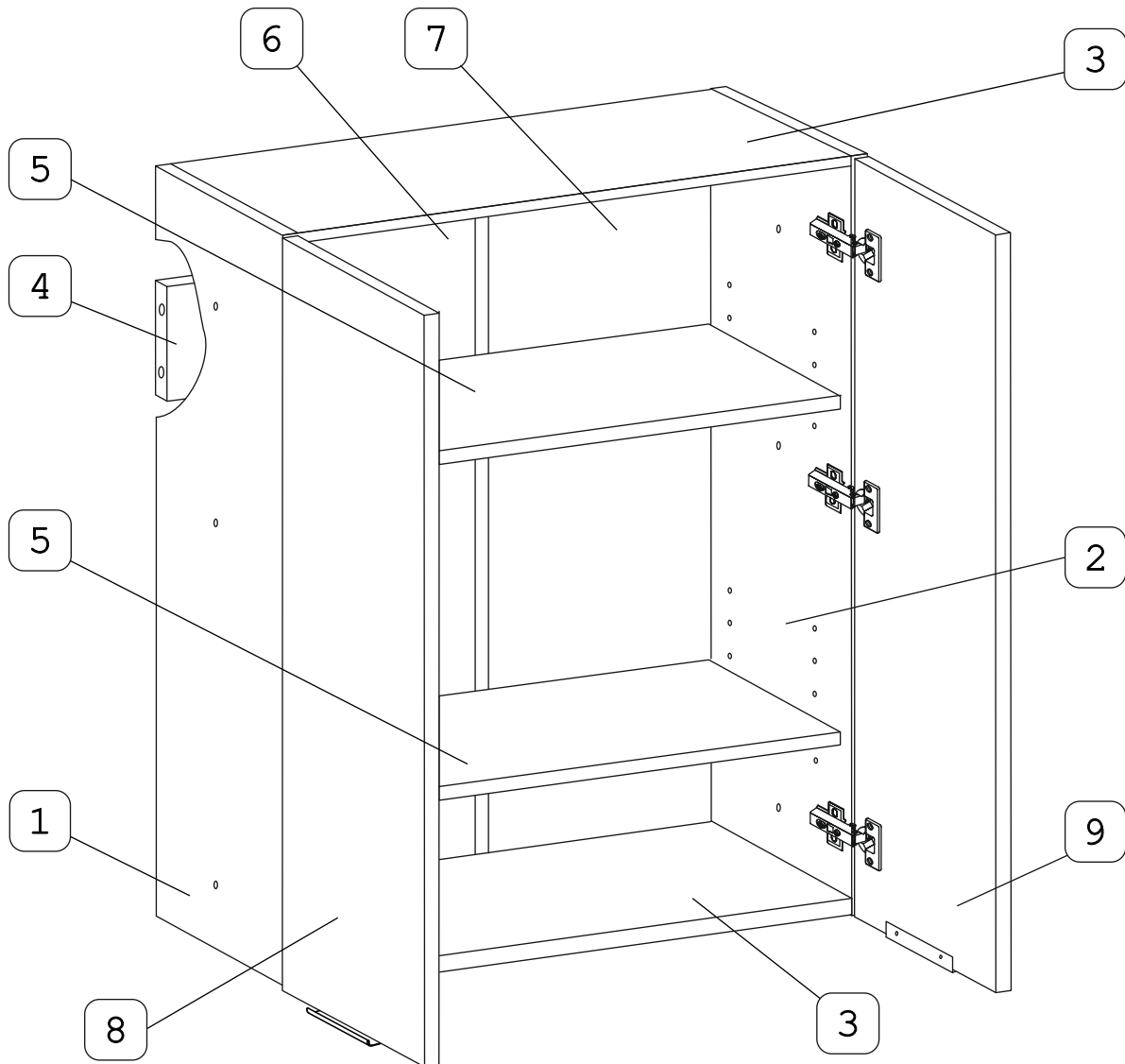

“Флоренция” Шкаф (800x320x960)



Наименование деталей





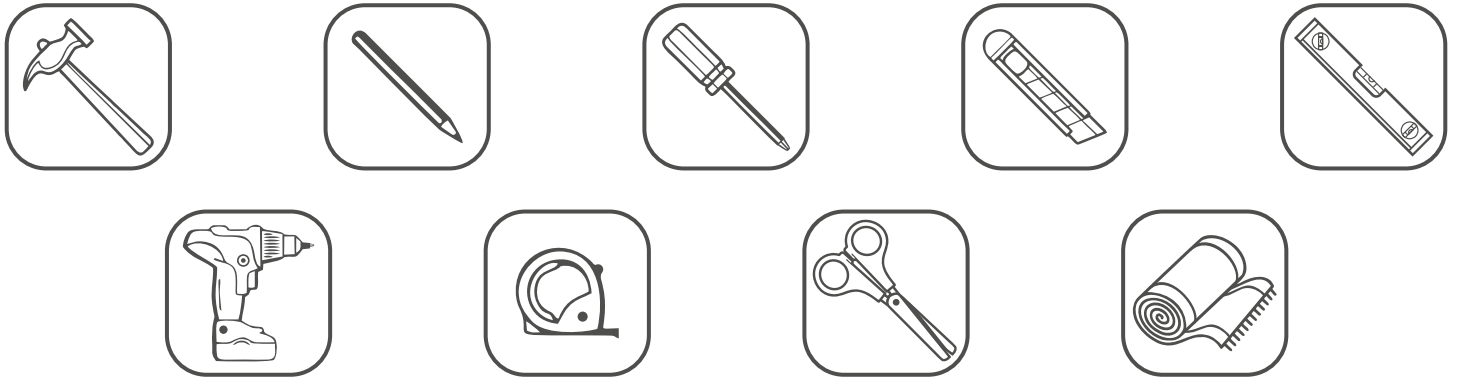





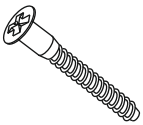

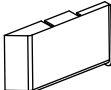
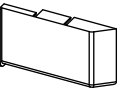

1. Боковина левая	960x305	1 шт.	6. Стенка левая ДВПО	945x392	1 шт.
2. Боковина правая	960x305	1 шт.	7. Стенка правая ДВПО	945x392	1 шт.
3. Полка стационарная	768x303	2 шт.	8. Дверь лев. МДФ ДР	955x397	1 шт.
4. Ригель	768x128	1 шт.	9. Дверь прав. МДФ ДР	955x397	1 шт.
5. Полка вкладная	766x267	2 шт.			

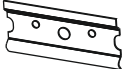
Необходимый инструмент

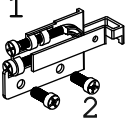
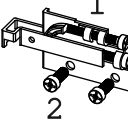

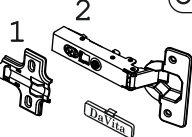
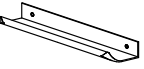
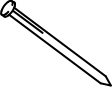
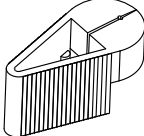
Установите на шуруповерте минимальные обороты!

Фурнитура в комплекте

						
Демпфер 4 шт.	Евровинт 50 12 шт.	Загл к ев. винту 12 шт.	Загл. самокл. Д14 53 шт.	Стыков. профиль 1 шт. (L=923)	Заглушка Scarpi-4 лев 1 шт.	Заглушка Scarpi-4 прав 1 шт.
						
Шуруп 4x16 24 шт.	Крепеж полоса 2 шт.	Стяжка 30 мм 3 компл.	Навес Scarpi-4 лев 1 шт.	Навес Scarpi-4 прав 1 шт.	П/д "Дупло" 8 шт.	Петля накл. с доводчиком и с заглушкой 6 шт.
					 <p>Максимальная полезная нагрузка на модуль до 70 кг.</p>	
Ручка P434 2 шт.	Гвоздь 1,6x25 12 шт.	Держатель для гвоздя 1 шт.	Шуруп 3x12 потай 4 шт.	Демпфер Д5 4 шт.		



Рис. 1



Рис. 2

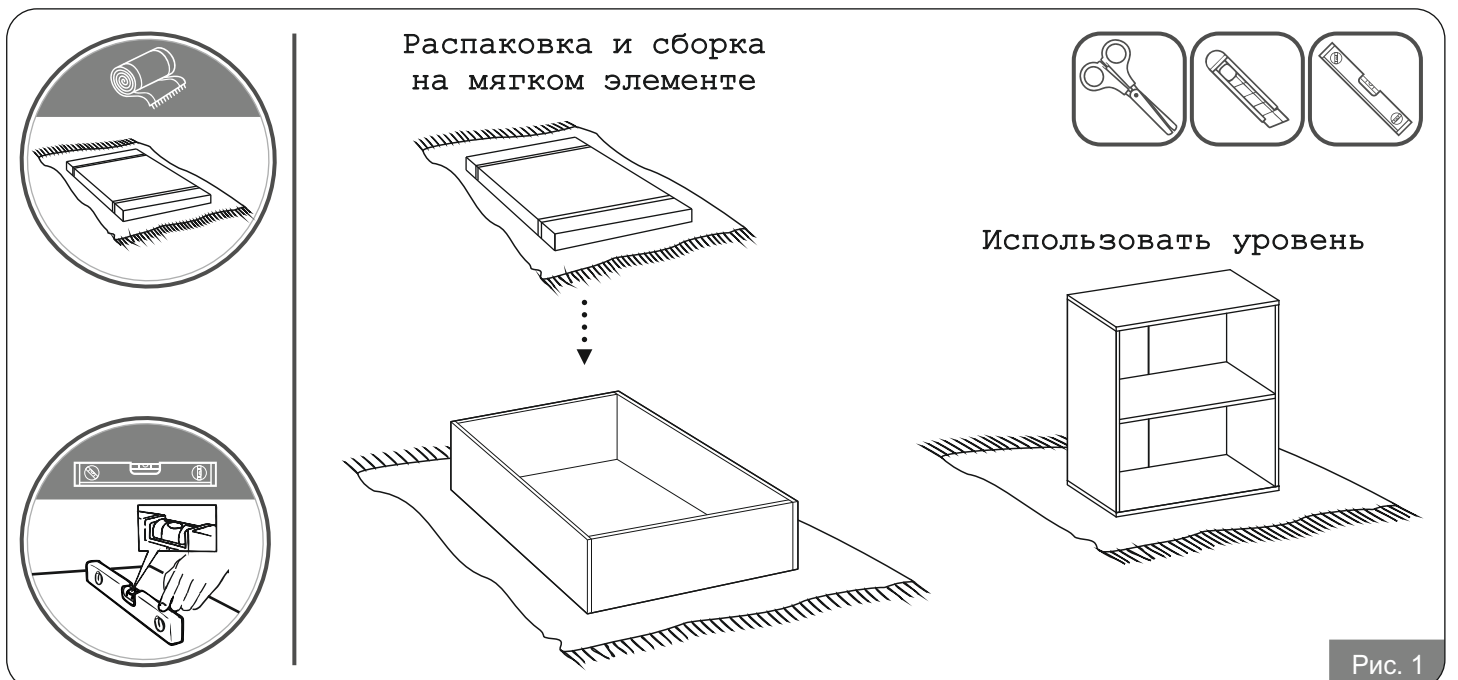

Рис. 3

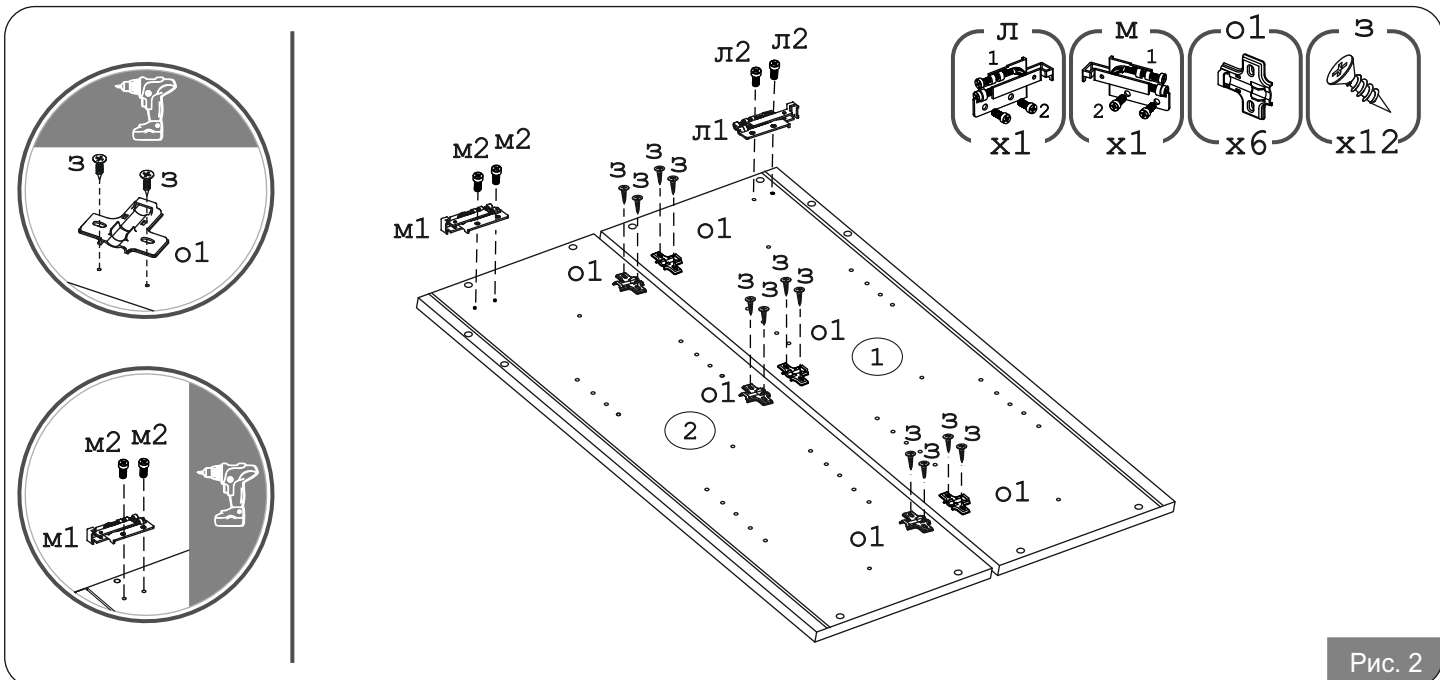

Рис. 4

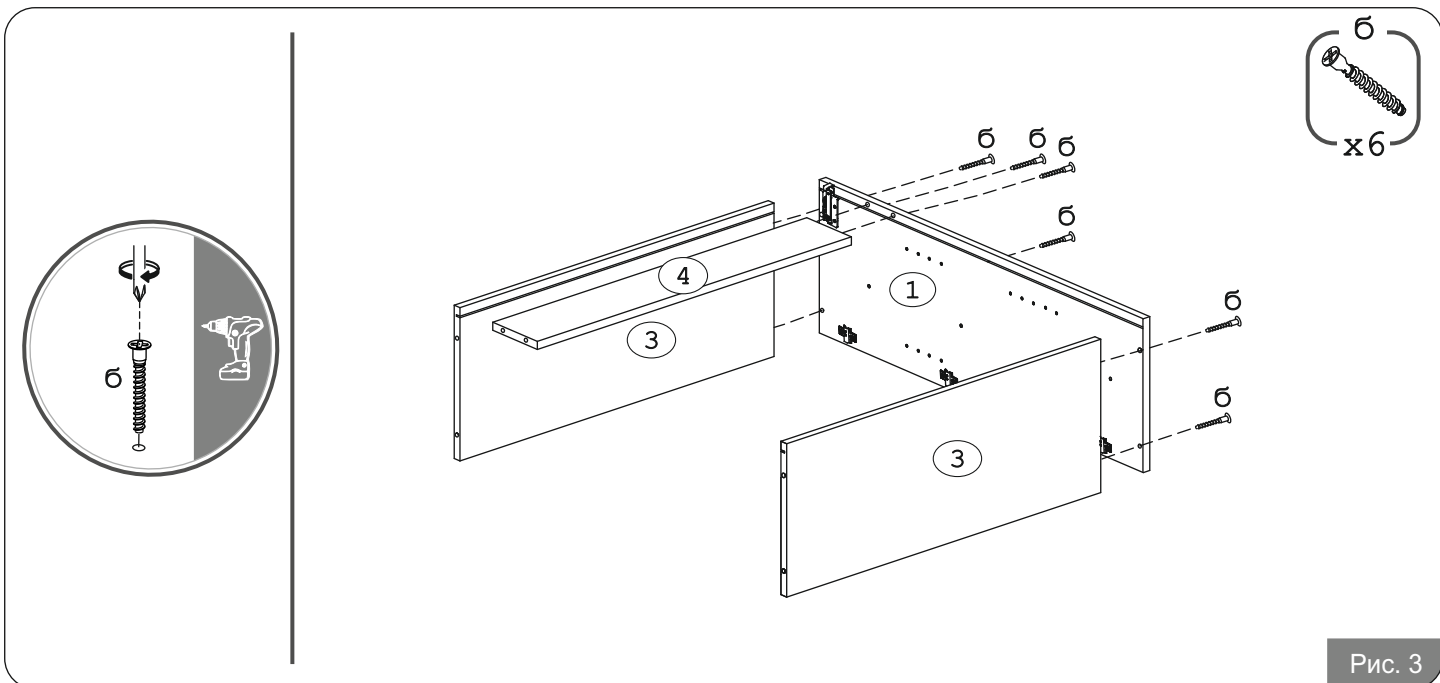

Рис. 5

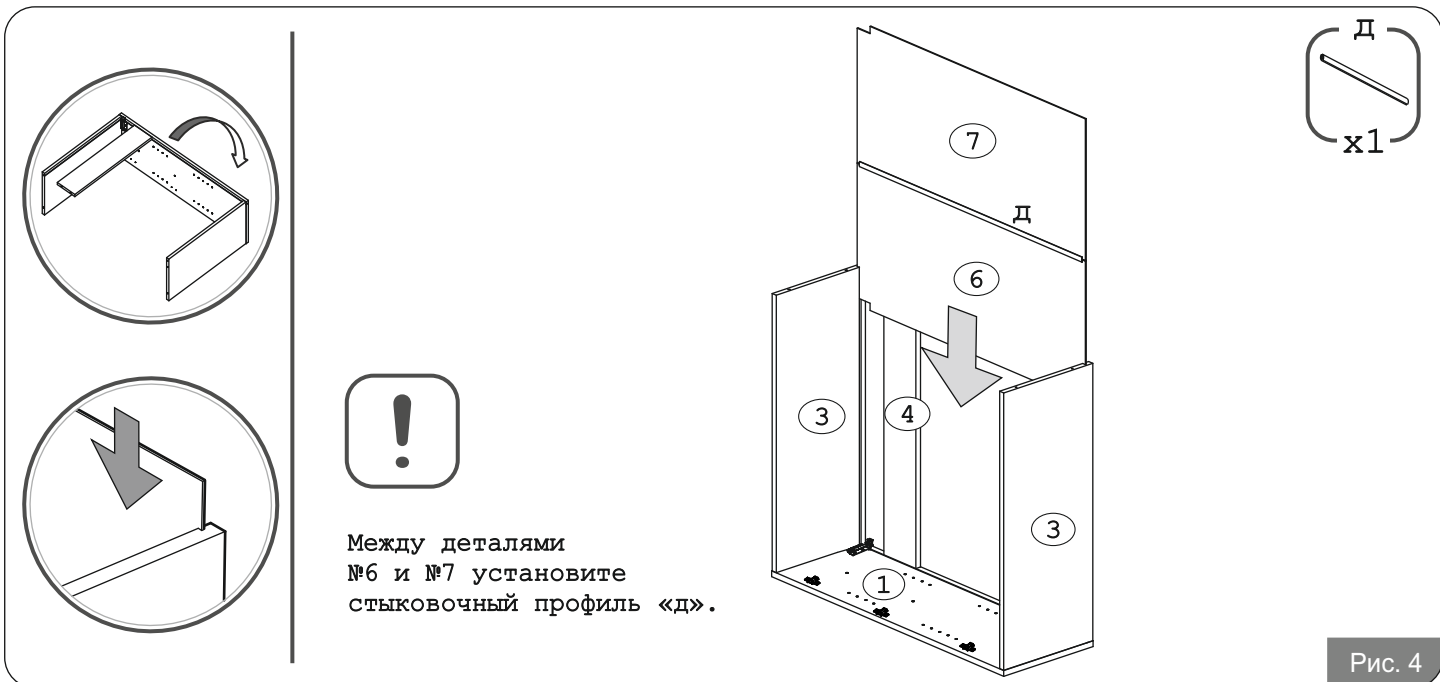

Сторона со
стенкой ДВПО

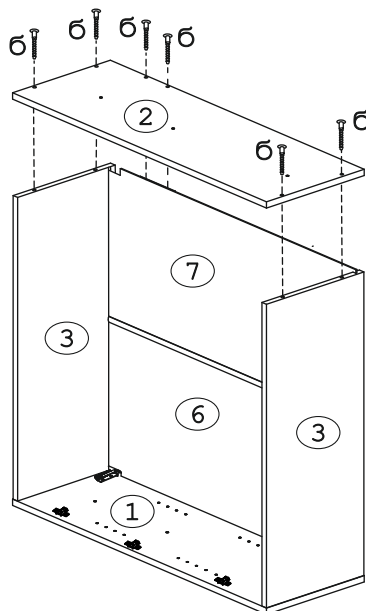
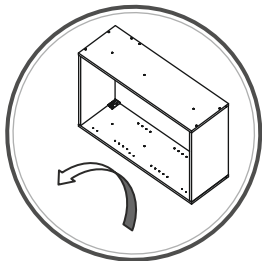
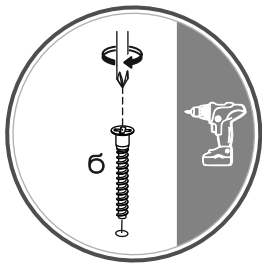
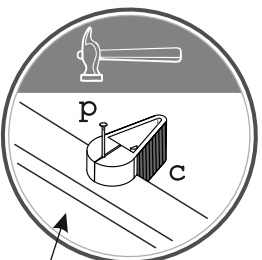
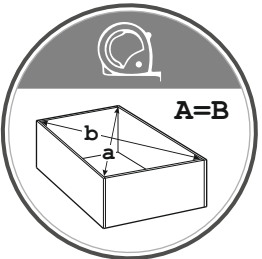

Рис. 6



Рис. 7

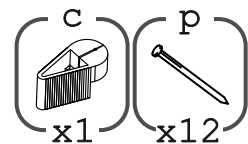
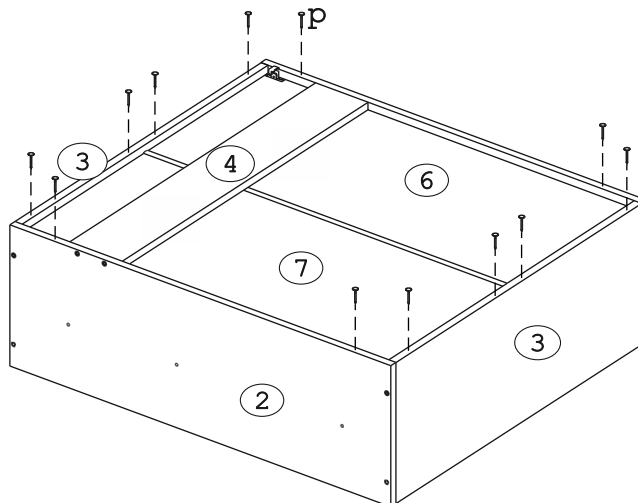

Рис. 8

Регулировка петель

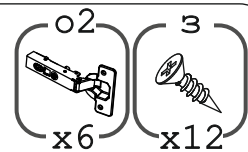
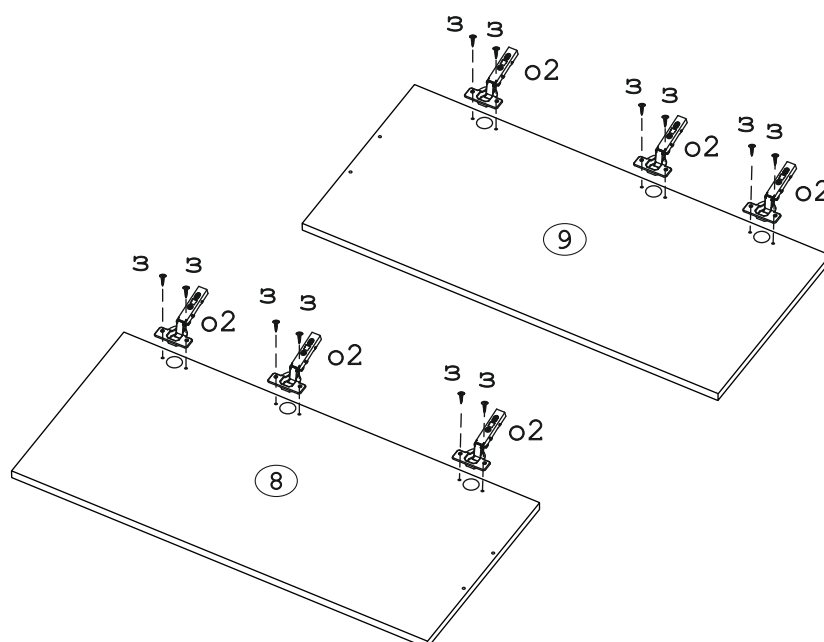
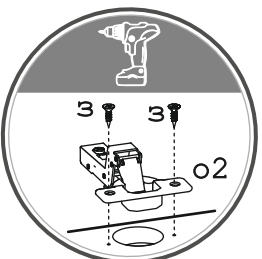
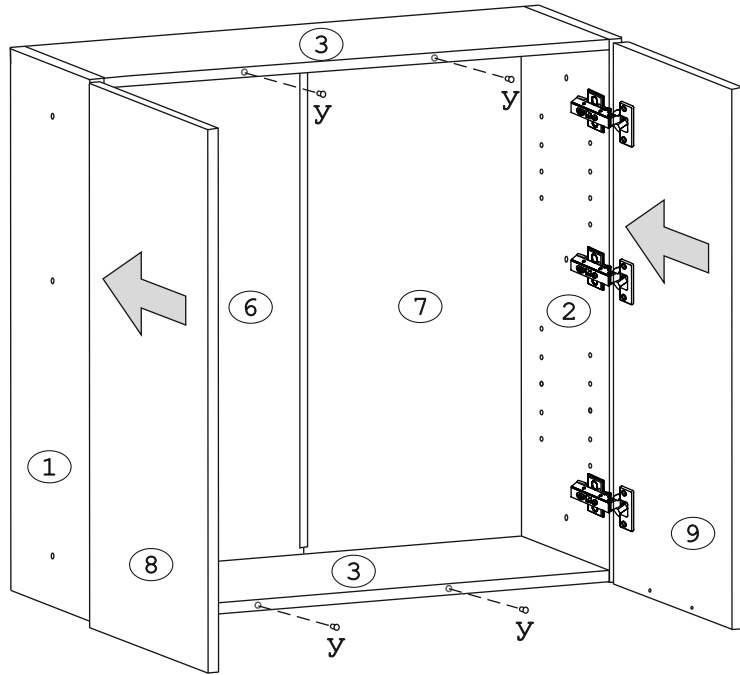
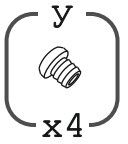
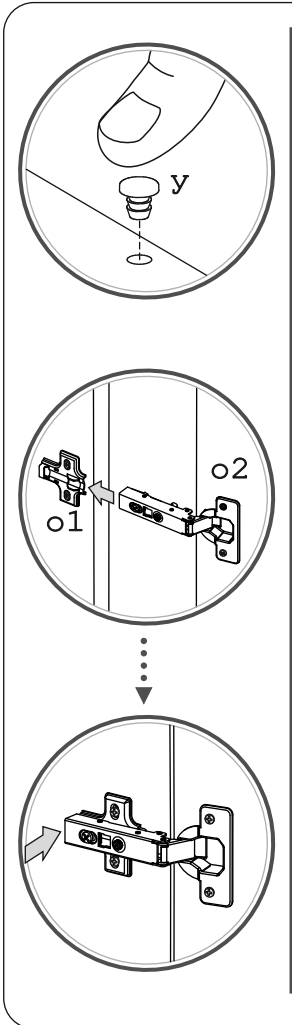
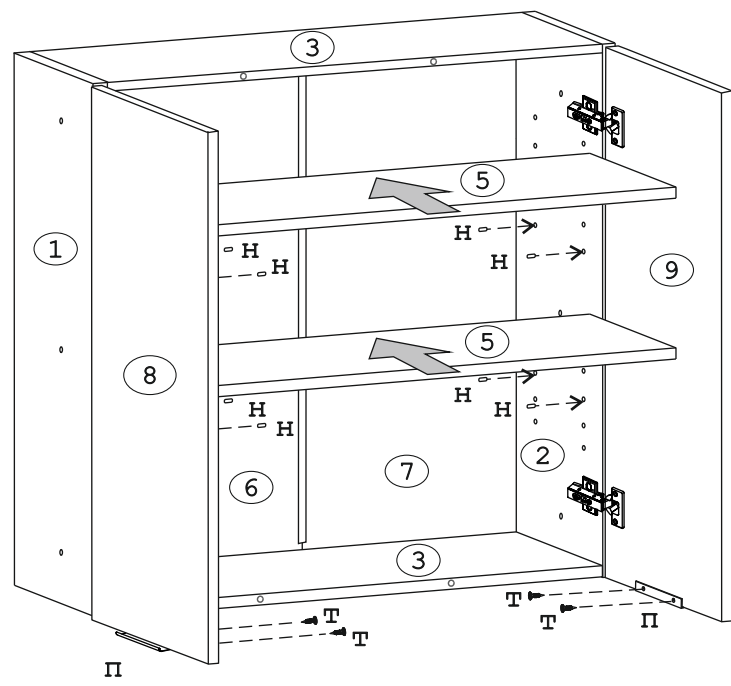
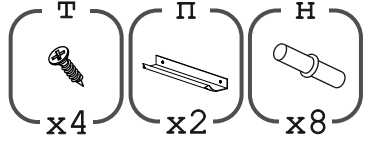
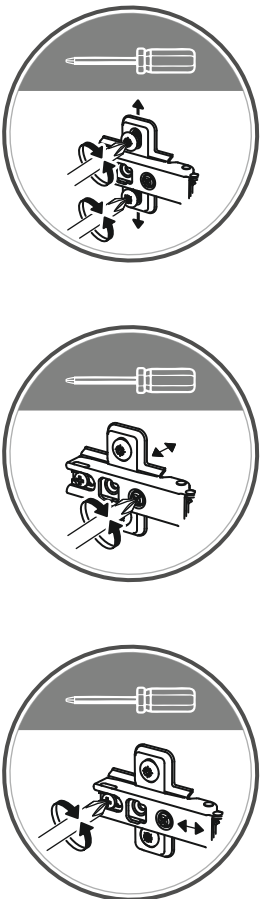

Рис. 9