

Стул «Статус» (480x560x790)

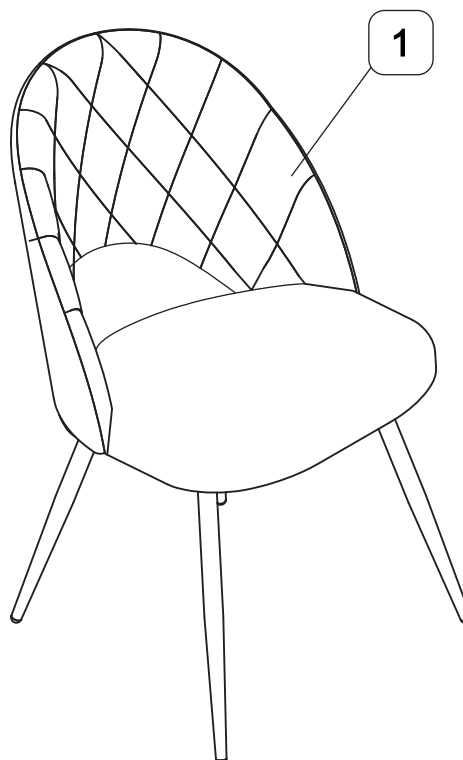





Наименование деталей

1. Сидение 480x560x410 1 шт.

Необходимый инструмент

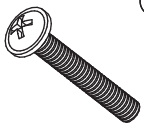

Фурнитура в комплекте

	а		б		в		г
Винт М6х40 с пресс шайбой	5 шт	Шайба-гровер Д6	5 шт	В комплекте заглушка d20 сфер.	СК Нг 37 верх.	В комплекте заглушка d20 сфер.	СК Нг 37 низ.
					1 шт		1 шт

Распаковка и сборка на мягком элементе



Рис. 1



Винт наживить, но не затягивать.



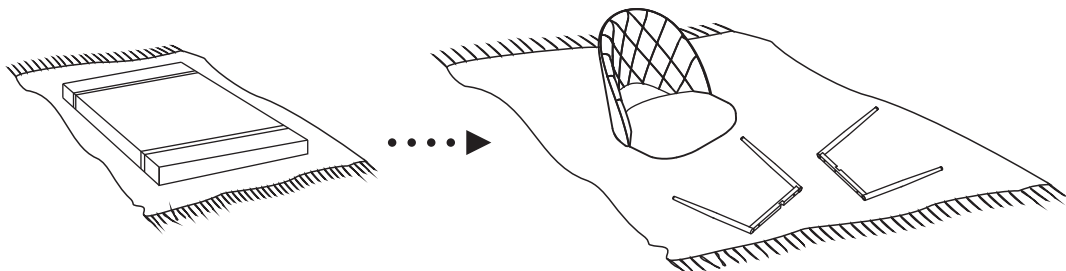
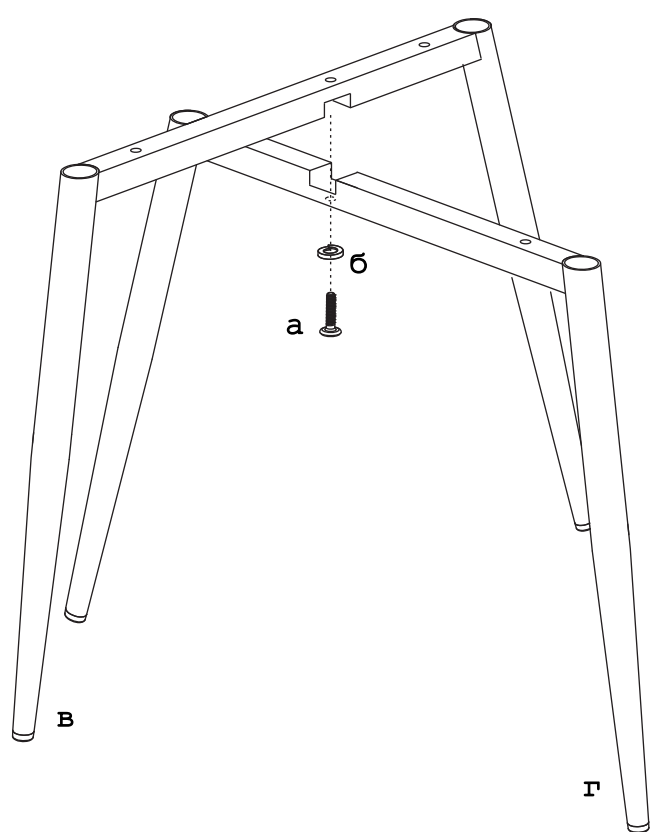
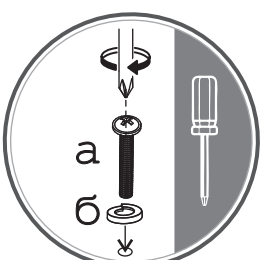



-  а
x1
-  б
x1
-  в
x1
-  г
x1

Рис. 2

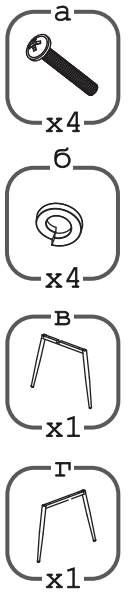

Рис. 3

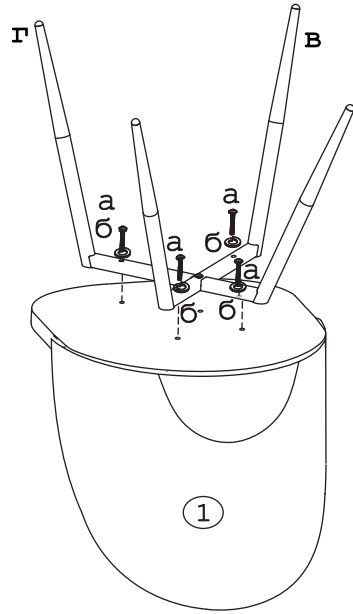
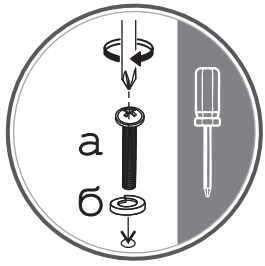
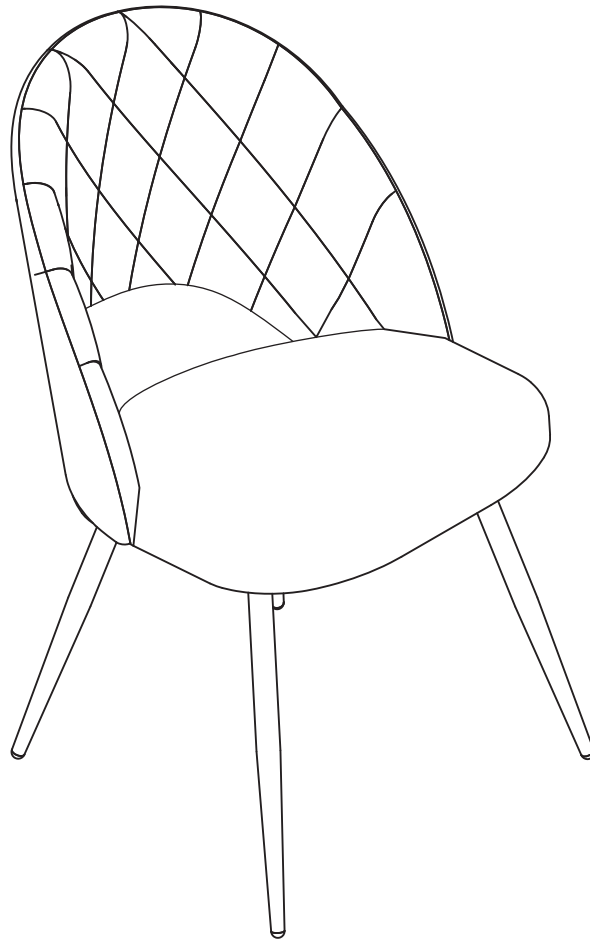

Рис. 4